

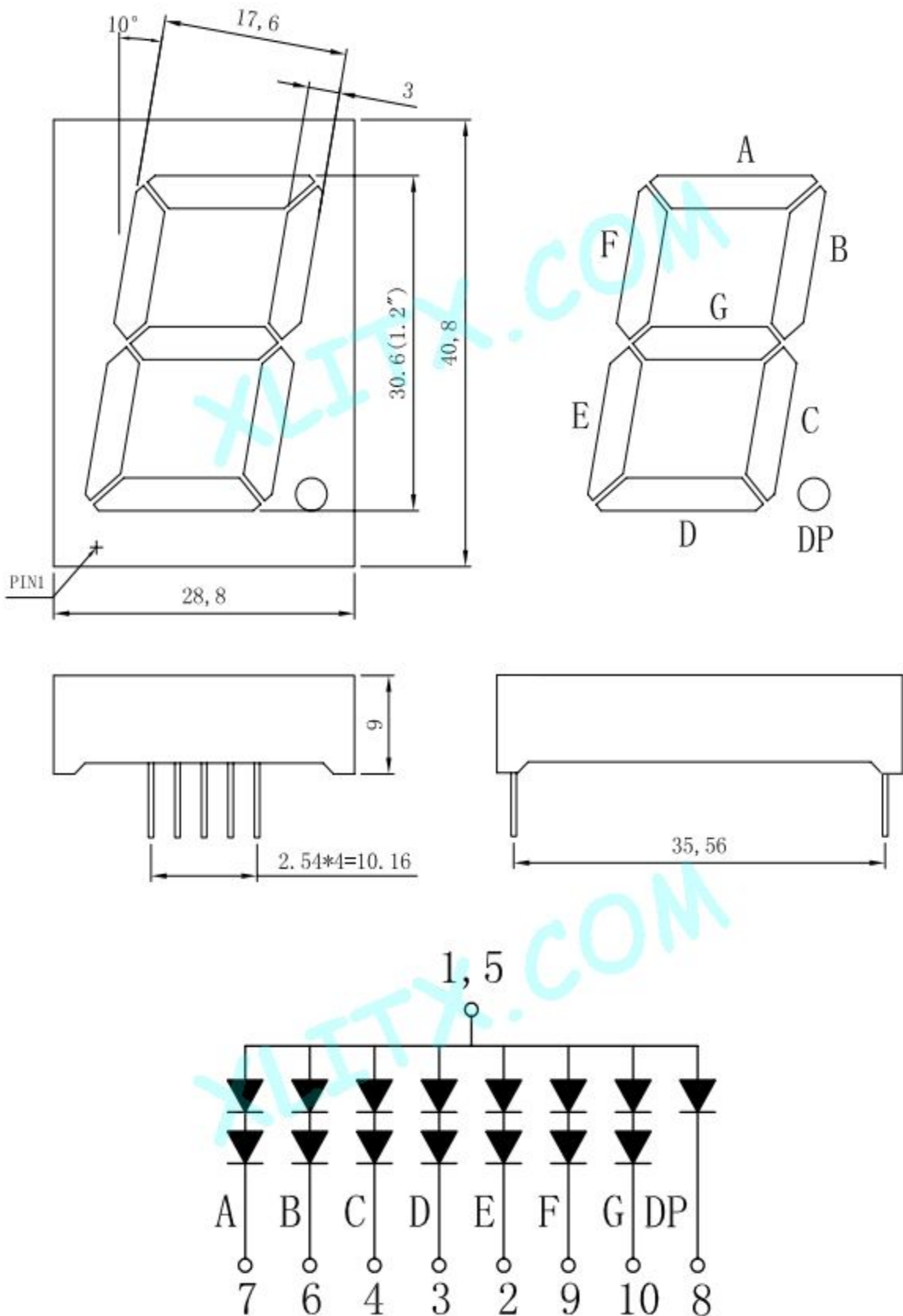

**Model :** 12101BW  
**Size :** 1.20-inch  
**Emitting color :** White  
**Mode :** Common-Anode (CA)  
**Digit :** 1-Digit  
**Category :** LED 7-Segment Display  
**Maker :** XLITX Technology

**Prices :** \$0.94 = 100 Pieces    \$0.60 = 500 Pieces    \$0.58 = 1000 Pieces    (Free shipping)

Dimension & Diagram



## White Electro-Optical Parameter

### 1. Electro-Optical Characteristics(Ta=25°C)

PARAMETER	SYMBOL	DEVICES ( White )		UNIT	TEST CONDIONS
		TYP	MAX		
Peak Emission Wavelengrth	$\lambda_p$	470		nm	IF=10mA
Forward Voltage	VF	3.5		V	IF=10mA
Reverse Current	IR		50	$\mu$ A	VR=5V
Segment To Segment (Dot To Dot) Luminonous Intensity Ratio	IV-M	1.5:1			IF=20

### 2. Absolute Maximun Ratings(Ta=25°C)

PARAMETER	SYMBOL	DEVICES ( White )	UNIT
Power Dissipation Per Dice	pad	70	mw
Derating Linear From 25°C Per Dice		0.27	mA/°C
Continuous Forward Current Per Dice	laf	30	mA
Peak Forward Ourrent Per Dice (Duty Cycle 1/10,10KHz)	lpf	100	mA
Reverse Voltage Per Dice	Vr	5	V
Operating Temperature	Topr	-20°C (to) +75°C	
Storage Temperature	Tstg	-20°C (to) +85°C	
Solder Temperature		1.6 Inch Below Seating Place for 5 seconds at 230°C	

3. Electro-Optical Curve

